

MONITOUCH

V10 Replacement Guidance [UG30 series]

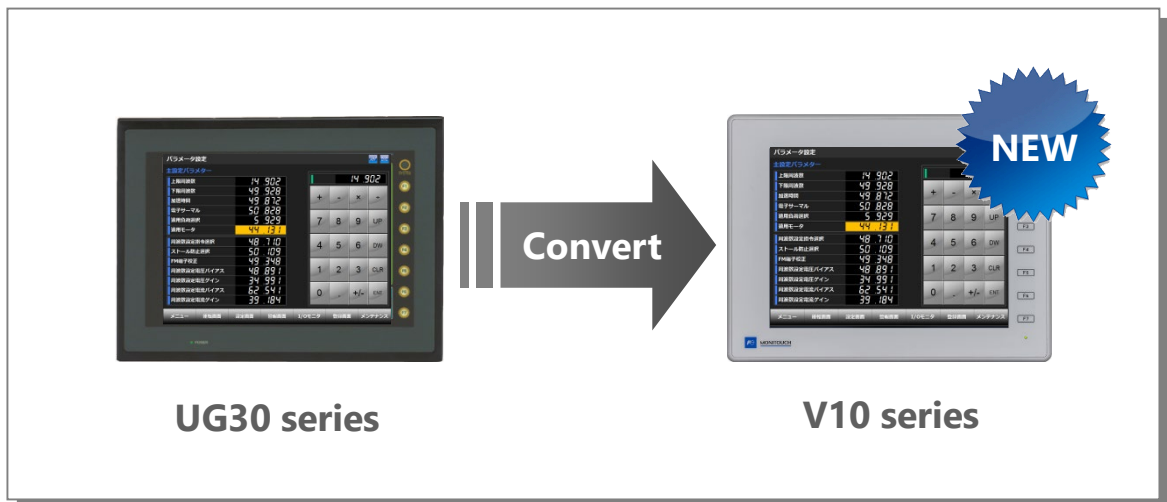

[- List of Recommended Replacement Models](#) Page 2

[- Configuration Software](#) Page 6

[- Screen Program Conversion](#) Page 6

List of Recommended Replacement Models

Following is a list of V10 replacement models for UG30 series. Please check the model of UG30 unit in use and select the recommended replacement model.

Size	UG30 model		V10 model		Refer to	
			Light Gray	Black		
15.0-inch XGA	UG630H-XH1	-	V1015iS	V1015iSB	Page 3	
	UG630H-XH4	-	V1015iSD	V1015iSBD		
12.1-inch SVGA	UG530H-VH1	UG530H-VS1	V1012iS	V1012iSB		
	UG530H-VH1D*1	UG530H-VS1D*1				
	UG530H-VH4	UG530H-VS4	V1012iSD	V1012iSBD		
10.4-inch SVGA	UG430H-VH1	UG430H-VS1	V1010iS	V1010iSB		
	UG430H-VH4	UG430H-VS4	V1010iSD	V1010iSBD		
8.4-inch SVGA	UG330H-VH4	UG330H-VS4	V1008iSD	V1008iSBD		
10.4-inch VGA With Video display With RGB display *2	UG430H-TH1	+ UG30A-xxx	V1010iS	V1010iSB		Page 4
	UG430H-TH1D*1	+ UG30A-xxx				
	UG430H-TH4	+ UG30A-xxx				
	UG430H-TH4D*1	+ UG30A-xxx	V1010iSD	V1010iSBD		
10.4-inch VGA Without Video display Without RGB display	UG430H-TH1	UG430H-TS1	If replaced with V10, the resolution will change from VGA to SVGA. If the same resolution model is required, use the V9 Lite model.		Page 5	
	UG430H-TH1D*1	UG430H-TS1D*1				
	UG430H-TH4	UG430H-TS4				
	UG430H-TH4D*1	UG430H-TS4D*1				
10.4-inch VGA	UG430H-SS1	UG430H-SS1D*1	There are no 5.7-inch models in the V10 series. Use TS2060i which has the same size and resolution.		-	
	UG430H-SS4	UG430H-SS4D*1				
7.7-inch VGA	UG330H-SS4	-				
5.7-inch QVGA	UG230H-TS4	UG230H-TS4D*1				
	UG230H-SS4	UG230H-SS4D*1				
	UG230H-LS4	UG230H-LS4D*1				

*1 The "D" in the model number means matrix resistance film model. The touch switches have been changed to analog resistance film in V10.

*2 When using Video/RGB display, the resolution will be changed by replacing with V10. The Video/RGB display function of V10 is scheduled to be supported in spring 2025.

* Models with few restrictions on use are described above list of recommended replacement models. It is also possible to replace UG30 with V10 other than the recommended model. Select the model according to your system.

Model Description

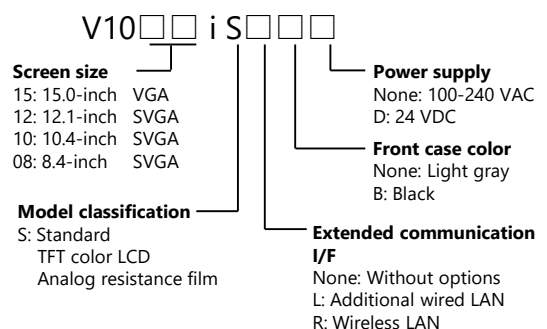
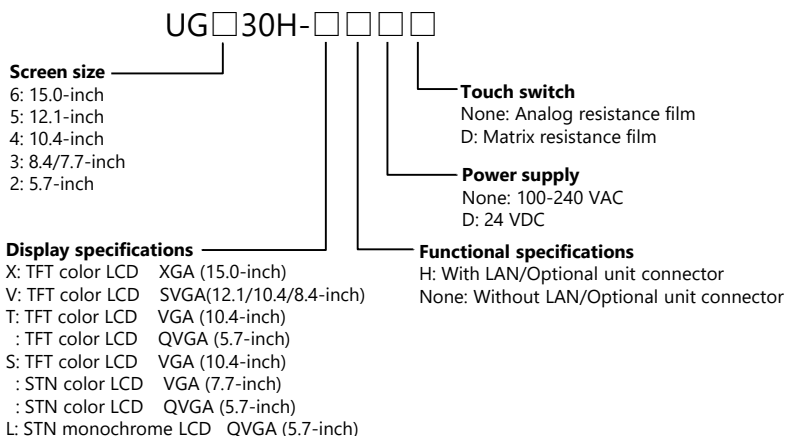

- UG630H/UG530H/UG430H-V/UG330H-V → V10 Standard

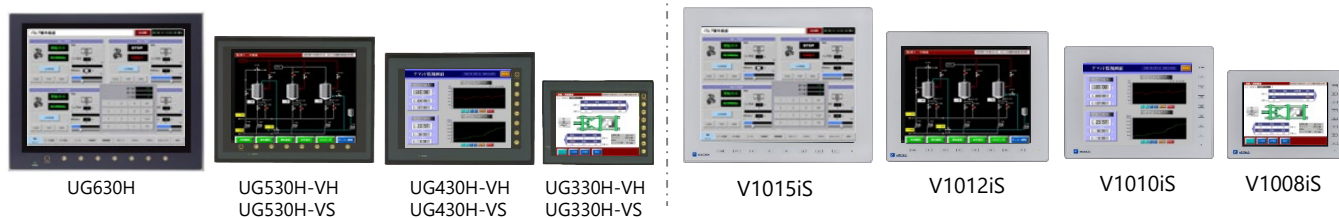

Hardware Specifications

Item		UG630H/UG530H/UG430H/UG330H	V10 Standard
Dimensions W x H x D (mm)	15.0-inch	382.8 x 312.8 x 81.1	382.8 x 312.8 x 79.2
	12.1-inch	326.4 x 259.6 x 72.0	327.8 x 261.0 x 53.4
	10.4-inch	303.8 x 231.0 x 72.0	303.8 x 231.0 x 53.8
	8.4-inch	233.0 x 178.0 x 66.1	235.0 x 180.0 x 48.7
Panel cut-out W x H (mm)	15.0-inch	369.4(+0.5/-0) x 299.4(+0.5/-0)	Same as on the left
	12.1-inch	313.0(+0.5/-0) x 246.2(+0.5/-0)	
	10.4-inch	289.0(+0.5/-0) x 216.2(+0.5/-0)	
	8.4-inch	220.5(+0.5/-0) x 165.5(+0.5/-0)	
Display device		TFT color	Same as on the left
Display colors		65,536 colors	16.7 million colors *1
Resolution	15.0-inch	1024 x 768 dots	Same as on the left
	12.1/10.4/8.4-inch	800 x 600 dots	
Touch switch		Analog resistance film Matrix resistance film	Analog resistance film *2
Communication I/F	Serial	D-Sub 25-pin x1 : RS-232C / RS-422/485 Modular 8-pin x2 : RS-232C / RS-485	D-Sub 9-pin x1 : RS-232C / RS-422/485 *3 Modular 8-pin x2 : RS-232C / RS-485
	USB	For 15.0-inch model only USB-A x1, USB-B x1	USB-A x1, USB mini-B x1
	Ethernet	For 15.0-inch model and "-VH" model only LAN x1: Standard equipment	LAN x1 : Standard equipment LAN2 x1 : Optional equipment *4
	Wireless LAN	Not available	WLAN x1 Optional equipment *4
	Network	Communication unit: UG03I-x	Communication unit: CUR-xx
Audio output	15.0-inch	Optional unit: UG00A-xxx (xxx: VIS, RIS, ROS, SUD)	Standard equipment
	12.1/10.4/8.4-inch	Optional unit: UG30A-xxx (xxx: VIS, RIS, ROS, SUD)	
Video/RGB	15.0-inch	Optional unit: UG00A-xxx (xxx: VIS, RIS, ROS, VRI,RI2)	Under development Scheduled to be released in spring 2025.
	12.1/10.4/8.4-inch	Optional unit: UG30A-xxx (xxx: VIS, RIS, ROS, VRI,RI2)	
External storage device		CF card For 15.0-inch model only USB flash drive	SD/SDHC/SDXC card USB flash drive

*1 Only for displaying "picture" images, 3D parts, video / RGB input images and remote desktop window. All other content is displayed using 65,536 colors.

*2 It is not possible to press two points on the screen at the same time on V10. For two-point press, change the setting to use both a switch on the screen and a function switch.

*3 When using the existing cable, use Hakko Electronics' conversion cable "D9-D25". When using Hakko Electronics' optional unit "UG00P-TC", use "TC-D9".

*4 LAN2 is supported only for models with "L" in the model number. Wireless LAN is supported only for models with "R" in the model number.

- UG430H-TH+UG30A-xxx → V10 Standard

The optional Video/RGB unit of V10 is scheduled to be released in spring 2025.

When using UG430H-TH + UG30A-xxx to display video/RGB, replace with V1010iS.

The screen resolution differs between UG430H-TH and V1010iS.

UG430H-TH : 640 x 480 → V1010iS: 800 x 600 dots

When converting the screen program from UG30 to V10, use automatic resizing feature of V-SFT. If the layout is changed, adjust it manually.



UG430H-TH

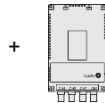

UG30A-xxx



V1010iS

+ Optional unit
Under development

Hardware Specifications

Item		UG430H-TH + UG30A-xxx	V1010iS
Dimensions W x H x D (mm)		303.8 x 231.0 x 72.0	303.8 x 231.0 x 53.8
Panel cut-out W x H (mm)		289.0(+0.5/-0) x 216.2(+0.5/-0)	Same as on the left
Display device		TFT color	Same as on the left
Display colors		32,768 colors	16.7 million colors *1
Resolution		640 x 480 dots	800 x 600 dots *2
Touch switch		Analog resistance film Matrix resistance film	Analog resistance film *3
Communication I/F	Serial	D-Sub 25-pin x1 : RS-232C / RS-422/485 Modular 8-pin x2 : RS-232C / RS-485	D-Sub 9-pin x1 : RS-232C / RS-422/485 *4 Modular 8-pin x2 : RS-232C / RS-485
	Ethernet	LAN x1: Standard equipment	LAN x1 : Standard equipment LAN2 x1 : Optional equipment *5
	Network	Communication unit: UG031-x	Communication unit: CUR-xx
Audio output		Optional unit: UG30A-xxx (xxx: VIS, RIS, ROS, SUD)	Standard equipment
Video/RGB		Optional unit: UG30A-xxx (xxx: VIS, RIS, ROS, VRI,RI2)	Under development Scheduled to be released in spring 2025.
External storage device		CF card	SD/SDHC/SDXC card USB flash drive

*1 Only for displaying "picture" images, 3D parts, video / RGB input images and remote desktop window. All other content is displayed using 65,536 colors.

*2 The resolution is SVGA. When converting the screen program, use automatic resizing feature of V-SFT. If the layout is changed, adjust it manually.

*3 It is not possible to press two points on the screen at the same time on V10. For two-point press, change the setting to use both a switch on the screen and a function switch.

*4 When using the existing cable, use Hakko Electronics' conversion cable "D9-D25". When using Hakko Electronics' optional unit "UG00P-TC", use "TC-D9".

*5 LAN2 is supported only for models with "L" in the model number.

- UG430H-T/UG430H-SS/UG330H-SS → V10 Standard

The screen resolution differs between UG430H-T/UG430H-SS/UG330H-SS and V10 Standard.
 UG30: 640 x 480 → V10: 800 x 600 dots

If the same resolution model is required, use the V9 Lite model.

When converting the screen program from UG30 to V10, use automatic resizing feature of V-SFT. If the layout is changed, adjust it manually.

Recommended Replacement Models

Size	UG30 model		V10 model	
			Light gray	Black
10.4-inch VGA	UG430H-TH1	UG430H-TS1	V1010iS	V1010iSB
	UG430H-TH1D*1	UG430H-TS1D*1		
	UG430H-TH4	UG430H-TS4	V1010iSD	V1010iSBD
	UG430H-TH4D*1	UG430H-TS4D*1		
	UG430H-SS1	UG430H-SS1D*1	V1010iS	V1010iSB
	UG430H-SS4	UG430H-SS4D*1	V1010iSD	V1010iSBD
7.7-inch VGA	UG330H-SS4	-	V1008iSD	V1008iSBD

*1 The "D" in the model number means matrix resistance film model. The touch switches have been changed to analog resistance film in V10.



UG430H-TH
UG430H-TS



UG330H-SS



V1010iS



V1008iS

Hardware Specifications

Item		UG430H / UG330H-SS	V10 Standard
Dimensions W x H x D (mm)	10.4-inch	303.8 x 231.0 x 72.0	303.8 x 231.0 x 53.8
	7.7-inch	233.0 x 178.0 x 66.1	235.0 x 180.0 x 48.7
Panel cut-out W x H (mm)	10.4-inch	289.0(+0.5/-0) x 216.2(+0.5/-0)	Same as on the left
	7.7-inch	220.5(+0.5/-0) x 165.5(+0.5/-0)	
Display device		TFT color/STN color	TFT color
Display colors		32,768 colors, 128 colors	16.7 million colors *1
Resolution		640 x 480 dots	800 x 600 dots *2
Touch switch		Analog resistance film Matrix resistance film	Analog resistance film *3
Communication I/F	Serial	D-Sub 25-pin x1 : RS-232C / RS-422/485 Modular 8-pin x2 : RS-232C / RS-485	D-Sub 9-pin x1 : RS-232C / RS-422/485 *4 Modular 8-pin x2 : RS-232C / RS-485
	Ethernet	For model "-TH" only LAN x1: Standard equipment	LAN x1 : Standard equipment LAN2 x1 : Optional equipment *5
	Network	Communication unit: UG03I-x	Communication unit: CUR-xx
External storage device		CF card	SD/SDHC/SDXC card USB flash drive

*1 Only for displaying "picture" images, 3D parts, video / RGB input images and remote desktop window. All other content is displayed using 65,536 colors.

*2 The resolution is SVGA. When converting the screen program, use automatic resizing feature of V-SFT. If the layout is changed, adjust it manually.

*3 It is not possible to press two points on the screen at the same time on V10. For two-point press, change the setting to use both a switch on the screen and a function switch.

*4 When using the existing cable, use Hakko Electronics' conversion cable "D9-D25". When using Hakko Electronics' optional unit "UG00P-TC", use "TC-D9".

*5 LAN2 is supported only for models with "L" in the model number.

- Configuration Software

Model	Software	OS	Transferring cable *1
UG30	V-SFT-5	Windows Vista (32bit, 64bit) Windows 7 (32bit, 64bit) Windows 8 (32bit, 64bit) Windows 8.1 (32bit, 64bit) Windows 10 (32bit, 64bit)	- USB cable *2 (USB-B to USB-A) - LAN cable *3 - UG00C-T1 or V-CP (MJ to Dsub9) manufactured by Hakko Electronics Co., Ltd.
V10	V-SFT-6 Supported with version 6.2.0.0 or later	Windows 11(64bit)	- USB cable (USB mini-B to USB-A) - LAN cable *4 - UG00C-T1 or V-CP (MJ to Dsub9) manufactured by Hakko Electronics Co., Ltd.

*1 The screen program can be transferred via SD card/USB flash drive when using V10, CF card when using UG30 and CF card/USB flash drive when using UG630H.

*2 Available for UG630H only.

*3 Available for models with "-xH" in the model number or when UG031-Ex is installed on the UG30 unit.

*4 LAN connector of V10 supports Auto-MDIX. Straight/crossover cables can be used with or without HUB.

- Screen Program Conversion

The screen program can be converted from UG30 to V10 using V-SFT-6 (configuration software for V series).

- Conversion procedures

1. Start V-SFT and click [Open] in the Startup menu or [Open] in the [File] menu. The screen program file can also be opened by dragging it onto V-SFT-6. If using this method, proceed to step 4.
2. Change the file extension to [*.U3] in the [Open] dialog.

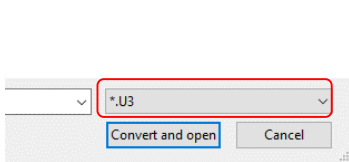

3. Select the UG30 series screen program file and click [Convert and open]. The [Edit Model Selection] dialog appears.

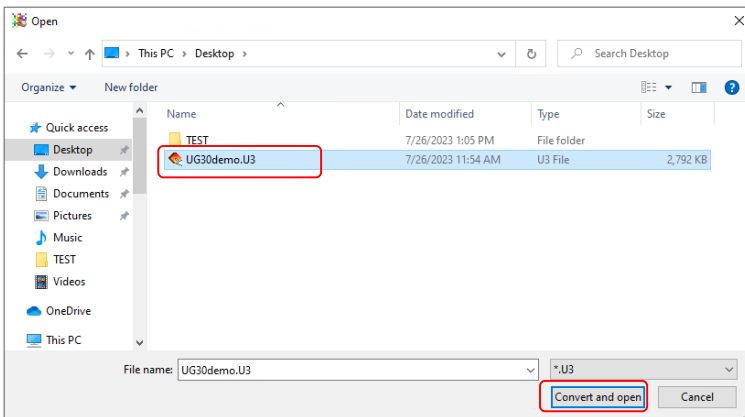

4. Select the V10 series model and click [OK].

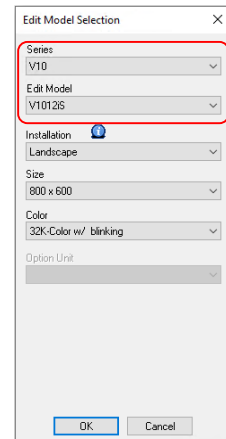
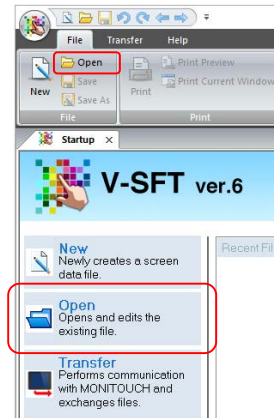

- The dialog on the right may be displayed.
When connecting to a printer : Click [Yes]
When not connecting to a printer : Click [No]

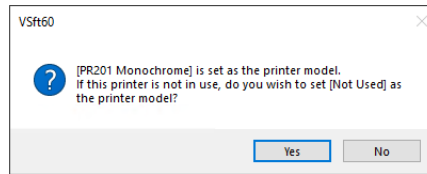

- The dialog on the right may be displayed.
Click [Yes].

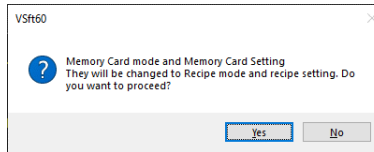

* The data conversion in the storage device is required. Refer to the Memory Card Mode Conversion Manual.

- When converting the program with different resolution, the dialog shown to the right will appear.
When enlarging parts: Click [Yes]
When not enlarging parts: Click [No]

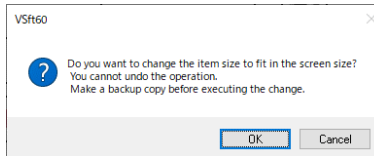

* If the layout is changed, adjust it manually.

- The following dialog may be displayed.
Click [Yes] to display the error check window and check the functions and setting which are not available.
Check [solution] and modify it.

If the same warning message appears even in the UG30 screen program before conversion, the warning does not affect the program and you can use it without modification.

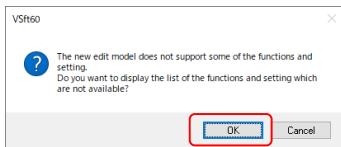

Error Check				
		0 Error	2 Warning	
Category	Location	Explanation	Solution	
Warning	Overlap Library [7]	Normal Overlap	Overlap larger than the screen is created.	Set the overlap
Warning	Overlap Library [8]	Normal Overlap	Overlap larger than the screen is created.	Set the overlap

- The screen program converted to V10 series is displayed on V-SFT. Name and save the file.

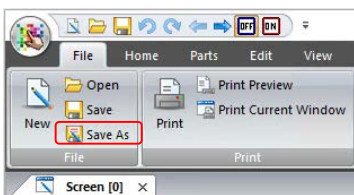

The converted V10 screen program cannot be converted back to the UG30 screen program. Confirm the operation with the V10 series unit before use.