

MONITOUCH

V8 Replacement Guidance [V7 series]

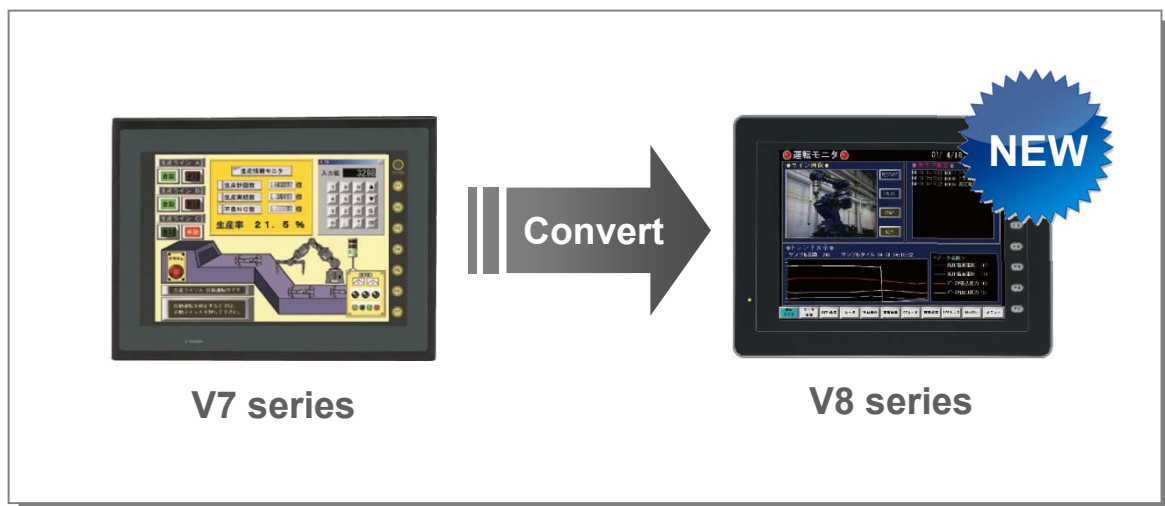

- V7 series models

The V7 series models are listed below.
Check the following recommended models for replacement according to the current V7 series model.

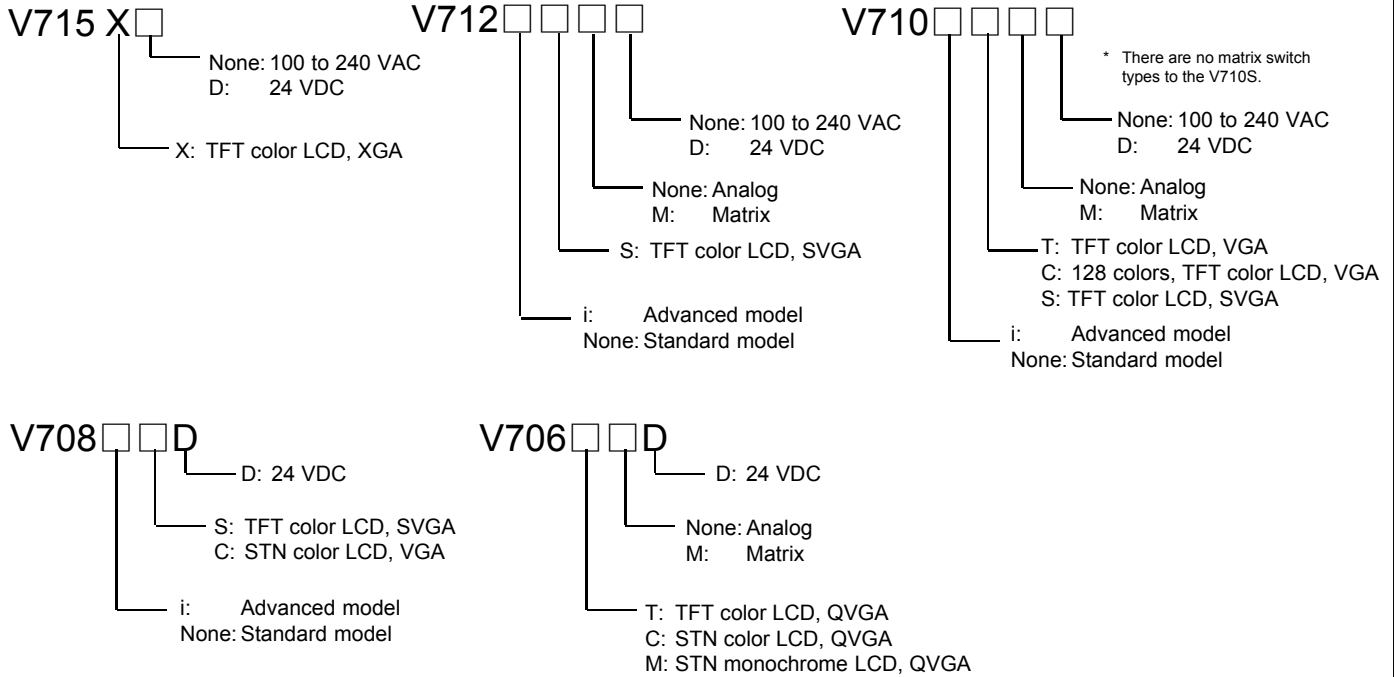



- Recommended models for replacement of V715 series

	V715 series		Recommended models for replacement	
	V715X	V715XD	V815iX/V815iXN	V815iXD/V815iXDN
MONITOUCH				
Panel cut-out dimensions (mm)				
Display device	TFT color		TFT color	
Colors	32,768 colors		65,536 colors	
Resolution	1024 × 768 dots		1024 × 768 dots	
Touch switch	Analog		Analog	
Communication I/F	D-sub 25-pin: RS-232C/422 Modular jack 8-pin (2 ports): RS-232C/RS-485		D-sub 9-pin: RS-232C/422 Modular jack 8-pin (2 ports): RS-232C/RS-485	
Power supply	100 to 240 VAC	24 VDC	100 to 240 VAC	24 VDC

*1 Use a V8-specific cable as a PLC connection cable. When using the existing cable, use Hakko Electronics' conversion cable "D9-D25".
 *2 When Hakko Electronics' optional unit "TC485" is used, use an optional terminal converter "TC-D9".
 *3 When Hakko Electronics' communication I/F unit "CU-xx" is currently used, it cannot be attached to V815iXN or V815iXDN. Use "CUN-xx" instead.

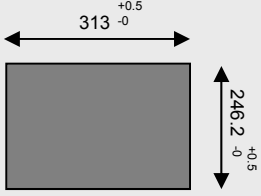
- Recommended models for replacement of V712 series (1)

	V712 series	
	V712S	V712SM
MONITOUCH		
Panel cut-out dimensions (mm)	 Width: 313 ^{+0.5} / ₋₀ mm Height: 246.2 ^{+0.5} / ₋₀ mm	
Display device	TFT color	
Colors	32,768 colors	
Resolution	800 × 600 dots	
Touch switch	Analog	Matrix
Communication I/F	D-sub 25-pin: RS-232C/422 Modular jack 8-pin (2 ports): RS-232C/RS-485	
Power supply	100 to 240 VAC	

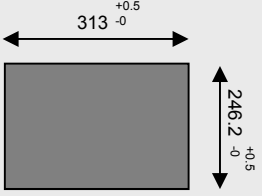
Recommended models for replacement	
V812S/V812SN	V812SM/V812SMN
	
 Width: 313 ^{+0.5} / ₋₀ mm Height: 246.2 ^{+0.5} / ₋₀ mm	
TFT color	
65,536 colors	
800 × 600 dots	
Analog	Matrix
D-sub 9-pin: RS-232C/422 Modular jack 8-pin (2 ports): RS-232C/RS-485	
100 to 240 VAC	

*1 Use a V8-specific cable as a PLC connection cable. When using the existing cable, use Hakko Electronics' conversion cable "D9-D25".

*2 When Hakko Electronics' optional unit "TC485" is used, use an optional terminal converter "TC-D9".

*3 When replaced with an analog switch model, two points on the screen cannot be pressed simultaneously. For two-point pressing, use a switch on the screen and a function switch.

*4 When Hakko Electronics' communication I/F unit "CU-xx" is currently used, it cannot be attached to V812SN or V812SMN. Use "CUN-xx" instead.

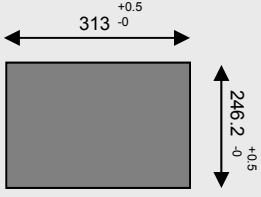
	V712 series	
	V712SD	V712SMD
MONITOUCH		
Panel cut-out dimensions (mm)	 Width: 313 ^{+0.5} / ₋₀ mm Height: 246.2 ^{+0.5} / ₋₀ mm	
Display device	TFT color	
Colors	32,768 colors	
Resolution	800 × 600 dots	
Touch switch	Analog	Matrix
Communication I/F	D-sub 25-pin: RS-232C/422 Modular jack 8-pin (2 ports): RS-232C/RS-485	
Power supply	24 VDC	

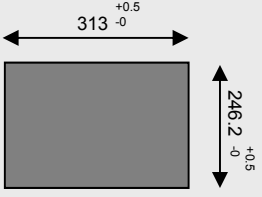
Recommended models for replacement	
V812SD/V812SDN	V812SMD/V812SMDN
	
 Width: 313 ^{+0.5} / ₋₀ mm Height: 246.2 ^{+0.5} / ₋₀ mm	
TFT color	
65,536 colors	
800 × 600 dots	
Analog	Matrix
D-sub 9-pin: RS-232C/422 Modular jack 8-pin (2 ports): RS-232C/RS-485	
24 VDC	

*1 Use a V8-specific cable as a PLC connection cable. When using the existing cable, use Hakko Electronics' conversion cable "D9-D25".

*2 When Hakko Electronics' optional unit "TC485" is used, use an optional terminal converter "TC-D9".

*3 When replaced with an analog switch model, two points on the screen cannot be pressed simultaneously. For two-point pressing, use a switch on the screen and a function switch.

*4 When Hakko Electronics' communication I/F unit "CU-xx" is currently used, it cannot be attached to V812SDN or V812SMDN. Use "CUN-xx" instead.

- Recommended models for replacement of V712 series (2)

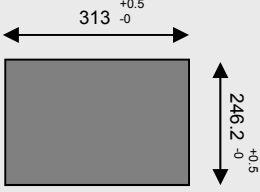
	V712 series	
	V712iS	V712iSM
MONITOUCH		
Panel cut-out dimensions (mm)	 313 ^{+0.5} ₋₀ (width) 246.2 ^{+0.5} ₋₀ (height)	
Display device	TFT color	
Colors	32,768 colors	
Resolution	800 × 600 dots	
Touch switch	Analog	Matrix
Communication I/F	D-sub 25-pin: RS-232C/422 Modular jack 8-pin (2 ports): RS-232C/RS-485	
Power supply	100 to 240 VAC	

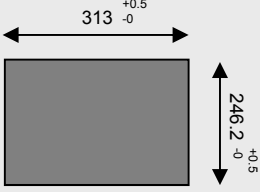
Recommended models for replacement	
V812iS/V812iSN	V812iSM/V812iSMN
	
 313 ^{+0.5} ₋₀ (width) 246.2 ^{+0.5} ₋₀ (height)	
TFT color	
65,536 colors	
800 × 600 dots	
Analog	Matrix
D-sub 9-pin: RS-232C/422 Modular jack 8-pin (2 ports): RS-232C/RS-485	
100 to 240 VAC	

*1 Use a V8-specific cable as a PLC connection cable. When using the existing cable, use Hakko Electronics' conversion cable "D9-D25".

*2 When Hakko Electronics' optional unit "TC485" is used, use an optional terminal converter "TC-D9".

*3 When Hakko Electronics' optional unit "EU-xx" is currently used, use "GU-xx".

*4 When replaced with an analog switch model, two points on the screen cannot be pressed simultaneously. For two-point pressing, use a switch on the screen and a function switch.

*5 When Hakko Electronics' communication I/F unit "CU-xx" is currently used, it cannot be attached to V812iSN or V812iSMN. Use "CUN-xx" instead.

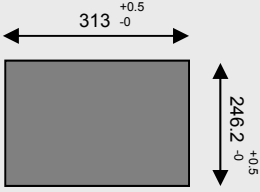
	V712 series	
	V712iSD	V712iSMD
MONITOUCH		
Panel cut-out dimensions (mm)	 313 ^{+0.5} ₋₀ (width) 246.2 ^{+0.5} ₋₀ (height)	
Display device	TFT color	
Colors	32,768 colors	
Resolution	800 × 600 dots	
Touch switch	Analog	Matrix
Communication I/F	D-sub 25-pin: RS-232C/422 Modular jack 8-pin (2 ports): RS-232C/RS-485	
Power supply	24 VDC	

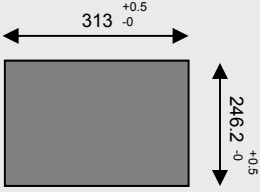
Recommended models for replacement	
V812iSD/V812iSDN	V812iSMD/V812iSMDN
	
 313 ^{+0.5} ₋₀ (width) 246.2 ^{+0.5} ₋₀ (height)	
TFT color	
65,536 colors	
800 × 600 dots	
Analog	Matrix
D-sub 9-pin: RS-232C/422 Modular jack 8-pin (2 ports): RS-232C/RS-485	
24 VDC	

*1 Use a V8-specific cable as a PLC connection cable. When using the existing cable, use Hakko Electronics' conversion cable "D9-D25".

*2 When Hakko Electronics' optional unit "TC485" is used, use an optional terminal converter "TC-D9".

*3 When Hakko Electronics' optional unit "EU-xx" is currently used, use "GU-xx".

*4 When replaced with an analog switch model, two points on the screen cannot be pressed simultaneously. For two-point pressing, use a switch on the screen and a function switch.

*5 When Hakko Electronics' communication I/F unit "CU-xx" is currently used, it cannot be attached to V812iSDN or V812iSMDN. Use "CUN-xx" instead.

- Recommended models for replacement of V710 series (1)

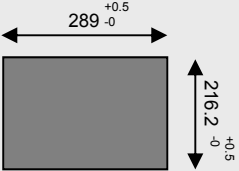
	V710S series	
	V710S	V710SD
MONITOUCH		
Panel cut-out dimensions (mm)		
Display device	TFT color	
Colors	32,768 colors	
Resolution	800 × 600 dots	
Touch switch	Analog	
Communication I/F	D-sub 25-pin: RS-232C/422 Modular jack 8-pin (2 ports): RS-232C/RS-485	
Power supply	100 to 240 VAC	24 VDC

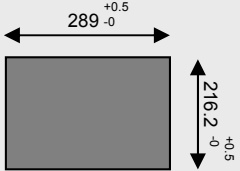
Recommended models for replacement	
V810S/V810SN	V810SD/V810SDN
	
	
TFT color	
65,536 colors	
800 × 600 dots	
Analog	
D-sub 9-pin: RS-232C/422 Modular jack 8-pin (2 ports): RS-232C/RS-485	
100 to 240 VAC	24 VDC

*1 Use a V8-specific cable as a PLC connection cable. When using the existing cable, use Hakko Electronics' conversion cable "D9-D25".

*2 When Hakko Electronics' optional unit "TC485" is used, use an optional terminal converter "TC-D9".

*3 When replaced with an analog switch model, two points on the screen cannot be pressed simultaneously. For two-point pressing, use a switch on the screen and a function switch.

*4 When Hakko Electronics' communication I/F unit "CU-xx" is currently used, it cannot be attached to V810SN or V810SDN. Use "CUN-xx" instead.

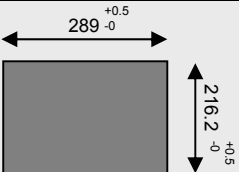
	V710iS series	
	V710iS	V710iSD
MONITOUCH		
Panel cut-out dimensions (mm)		
Display device	TFT color	
Colors	32,768 colors	
Resolution	800 × 600 dots	
Touch switch	Analog	
Communication I/F	D-sub 25-pin: RS-232C/422 Modular jack 8-pin (2 ports): RS-232C/RS-485	
Power supply	100 to 240 VAC	24 VDC

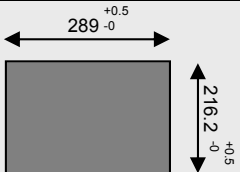
Recommended models for replacement	
V810iS/V810iSN	V810iSD/V810iSDN
	
	
TFT color	
65,536 colors	
800 × 600 dots	
Analog	
D-sub 9-pin: RS-232C/422 Modular jack 8-pin (2 ports): RS-232C/RS-485	
100 to 240 VAC	24 VDC

*1 Use a V8-specific cable as a PLC connection cable. When using the existing cable, use Hakko Electronics' conversion cable "D9-D25".

*2 When Hakko Electronics' optional unit "TC485" is used, use an optional terminal converter "TC-D9".

*3 When Hakko Electronics' optional unit "EU-xx" is currently used, use "GU-xx".

*4 When replaced with an analog switch model, two points on the screen cannot be pressed simultaneously. For two-point pressing, use a switch on the screen and a function switch.

*5 When Hakko Electronics' communication I/F unit "CU-xx" is currently used, it cannot be attached to V810iSN or V810iSDN. Use "CUN-xx" instead.

- Recommended models for replacement of V710 series (2)

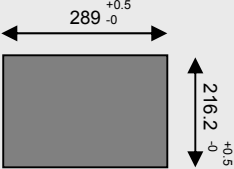
	V710T/V710C series			
	V710T	V710TM	V710C	V710CM
MONITOUCH				
Panel cut-out dimensions (mm)				
Display device	TFT color			
Colors	32,768 colors		128 colors	
Resolution	640 × 480 dots			
Touch switch	Analog	Matrix	Analog	Matrix
Communication I/F	D-sub 25-pin: RS-232C/422 Modular jack 8-pin (2 ports): RS-232C/RS-485			
Power supply	100 to 240 VAC			

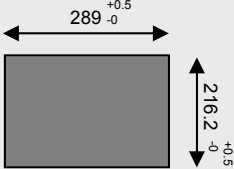
Recommended models for replacement			
V810T/ V810TN	V810TM/ V810TMN	V810C/ V810CN *4	V810CM/ V810CMN*4
			
			
TFT color			
65,536 colors			
640 × 480 dots			
Analog	Matrix	Analog	Matrix
D-sub 9-pin: RS-232C/422 Modular jack 8-pin (2 ports): RS-232C/RS-485			
100 to 240 VAC			

*1 Use a V8-specific cable as a PLC connection cable. When using the existing cable, use Hakko Electronics' conversion cable "D9-D25".
 *2 When Hakko Electronics' optional unit "TC485" is used, use an optional terminal converter "TC-D9".
 *3 When replaced with an analog switch model, two points on the screen cannot be pressed simultaneously. For two-point pressing, use a switch on the screen and a function switch.
 *4 When a V7-specific optional FROM cassette "V7EM-F" / "V7EM-L" or SRAM cassette "V7EM-S" is in use, replace with V810C/V810CN or V810CM/V810CMN.
 *5 When Hakko Electronics' communication I/F unit "CU-xx" is currently used, it cannot be attached to V810TN, V810TMN, V810(i)CN, or V810(i)CMN. Use "CUN-xx" instead.

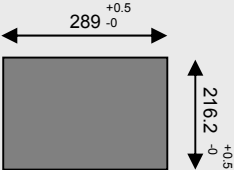
	V710T/V710C series			
	V710TD	V710TMD	V710CD	V710CMD
MONITOUCH				
Panel cut-out dimensions (mm)				
Display device	TFT color			
Colors	32,768 colors		128 colors	
Resolution	640 × 480 dots			
Touch switch	Analog	Matrix	Analog	Matrix
Communication I/F	D-sub 25-pin: RS-232C/422 Modular jack 8-pin (2 ports): RS-232C/RS-485			
Power supply	24 VDC			

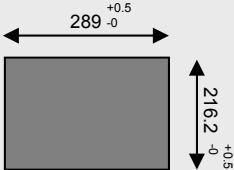
Recommended models for replacement			
V810TD/ V810TDN	V810TMD/ V810TMDN	V810CD/ V810CDN *4	V810CMD/ V810CMDN*4
			
			
TFT color			
65,536 colors			
640 × 480 dots			
Analog	Matrix	Analog	Matrix
D-sub 9-pin: RS-232C/422 Modular jack 8-pin (2 ports): RS-232C/RS-485			
24 VDC			

*1 Use a V8-specific cable as a PLC connection cable. When using the existing cable, use Hakko Electronics' conversion cable "D9-D25".
 *2 When Hakko Electronics' optional unit "TC485" is used, use an optional terminal converter "TC-D9".
 *3 When replaced with an analog switch model, two points on the screen cannot be pressed simultaneously. For two-point pressing, use a switch on the screen and a function switch.
 *4 When a V7-specific optional FROM cassette "V7EM-F"/"V7EM-L" or SRAM cassette "V7EM-S" is in use, replace with V810CD/V810CDN or V810CMD/V810CMDN.
 *5 When Hakko Electronics' communication I/F unit "CU-xx" is currently used, it cannot be attached to V810TDN, V810TMDN, V810(i)CDN, or V810(i)CMDN. Use "CUN-xx" instead.

- Recommended models for replacement of V710 series (3)

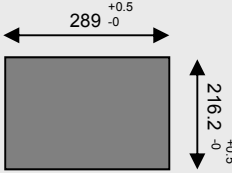
	V710T series	
	V710iT	V710iTM
MONITOUCH		
Panel cut-out dimensions (mm)		
Display device	TFT color	
Colors	32,768 colors	
Resolution	640 × 480 dots	
Touch switch	Analog	Matrix
Communication I/F	D-sub 25-pin: RS-232C/422 Modular jack 8-pin (2 ports): RS-232C/RS-485	
Power supply	100 to 240 VAC	

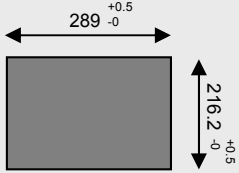
Recommended models for replacement			
V810iT/ V810iTN	V810iTM/ V810iTMN	V810iC/ V810iCN	V810iCM/ V810iCMN
			
			
TFT color			
65,536 colors			
640 × 480 dots			
Analog	Matrix	Analog	Matrix
D-sub 9-pin: RS-232C/422 Modular jack 8-pin (2 ports): RS-232C/RS-485			
100 to 240 VAC			

*1 Use a V8-specific cable as a PLC connection cable. When using the existing cable, use Hakko Electronics' conversion cable "D9-D25".
 *2 When Hakko Electronics' optional unit "TC485" is used, use an optional terminal converter "TC-D9".
 *3 When Hakko Electronics' optional unit "EU-xx" is currently used, use "GU-xx". (Only for V810iT, V810iTN, V810iTM, and V810iTMN)
 *4 When replaced with an analog switch model, two points on the screen cannot be pressed simultaneously.
 For two-point pressing, use a switch on the screen and a function switch.
 *5 When Hakko Electronics' communication I/F unit "CU-xx" is currently used, it cannot be attached to V810iTN, V810iTMN, V810iCN, or V810iCMN. Use "CUN-xx" instead.

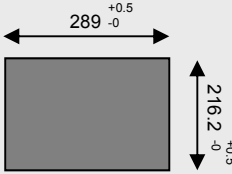
	V710T series	
	V710iTD	V710iTMD
MONITOUCH		
Panel cut-out dimensions (mm)		
Display device	TFT color	
Colors	32,768 colors	
Resolution	640 × 480 dots	
Touch switch	Analog	Matrix
Communication I/F	D-sub 25-pin: RS-232C/422 Modular jack 8-pin (2 ports): RS-232C/RS-485	
Power supply	24 VDC	

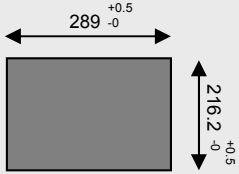
Recommended models for replacement			
V810iTD/ V810iTDN	V810iTMD/ V810iTMDN	V810iCD/ V810iCDN	V810iCMD/ V810iCMDN
			
			
TFT color			
65,536 colors			
640 × 480 dots			
Analog	Matrix	Analog	Matrix
D-sub 9-pin: RS-232C/422 Modular jack 8-pin (2 ports): RS-232C/RS-485			
24 VDC			

*1 Use a V8-specific cable as a PLC connection cable. When using the existing cable, use Hakko Electronics' conversion cable "D9-D25".
 *2 When Hakko Electronics' optional unit "TC485" is used, use an optional terminal converter "TC-D9".
 *3 When Hakko Electronics' optional unit "EU-xx" is currently used, use "GU-xx". (Only for V810iTD, V810iTDN, V810iTMD, and V810iTMDN)
 *4 When replaced with an analog switch model, two points on the screen cannot be pressed simultaneously.
 For two-point pressing, use a switch on the screen and a function switch.
 *5 When Hakko Electronics' communication I/F unit "CU-xx" is currently used, it cannot be attached to V810iTDN, V810iTMDN, V810iCDN, or V810iCMDN. Use "CUN-xx" instead.

- Recommended models for replacement of V708 series (1)

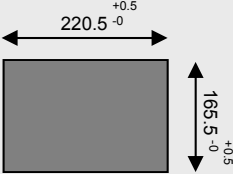
V708S series	
V708SD	
MONITOUCH	
Panel cut-out dimensions (mm)	
Display device	TFT color
Colors	32,768 colors
Resolution	800 × 600 dots
Touch switch	Analog
Communication I/F	D-sub 25-pin: RS-232C/422 Modular jack 8-pin (2 ports): RS-232C/RS-485
Power supply	24 VDC

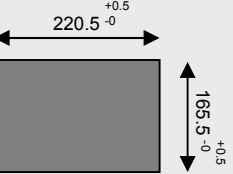
Recommended models for replacement	
V808SD/V808SDN	
	
	
	TFT color
	65,536 colors
	800 × 600 dots
	Analog
	D-sub 9-pin: RS-232C/422 Modular jack 8-pin (2 ports): RS-232C/RS-485
	24 VDC

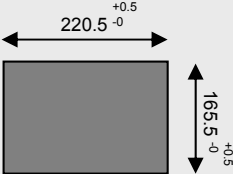

*1 Use a V8-specific cable as a PLC connection cable. When using the existing cable, use Hakko Electronics' conversion cable "D9-D25".
 *2 When Hakko Electronics' optional unit "TC485" is used, use an optional terminal converter "TC-D9".
 *3 When Hakko Electronics' communication I/F unit "CU-xx" is currently used, it cannot be attached to V808SDN. Use "CUN-xx" instead.

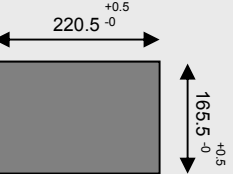
V708S series	
V708iSD	
MONITOUCH	
Panel cut-out dimensions (mm)	
Display device	TFT color
Colors	32,768 colors
Resolution	800 × 600 dots
Touch switch	Analog
Communication I/F	D-sub 25-pin: RS-232C/422 Modular jack 8-pin (2 ports): RS-232C/RS-485
Power supply	24 VDC

Recommended models for replacement	
V808iSD/V808iSDN	
	
	
	TFT color
	65,536 colors
	800 × 600 dots
	Analog
	D-sub 9-pin: RS-232C/422 Modular jack 8-pin (2 ports): RS-232C/RS-485
	24 VDC

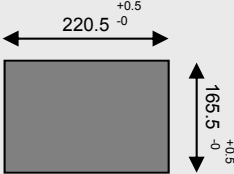
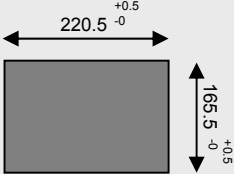

*1 Use a V8-specific cable as a PLC connection cable. When using the existing cable, use Hakko Electronics' conversion cable "D9-D25".
 *2 When Hakko Electronics' optional unit "TC485" is used, use an optional terminal converter "TC-D9".
 *3 When Hakko Electronics' optional unit "EU-xx" is currently used, use "GU-xx".
 *4 When Hakko Electronics' communication I/F unit "CU-xx" is currently used, it cannot be attached to V808iSDN. Use "CUN-xx" instead.

- Recommended models for replacement of V708 series (2)

V708C series		Recommended models for replacement	
V708CD		V808CD/V808CDN	
MONITOUCH			
Panel cut-out dimensions (mm)			
Display device	STN color	TFT color	
Colors	128 colors	65,536 colors	
Resolution	640 × 480 dots	640 × 480 dots	
Touch switch	Analog	Analog	
Communication I/F	D-sub 25-pin: RS-232C/422 Modular jack 8-pin (2 ports): RS-232C/RS-485	D-sub 9-pin: RS-232C/422 Modular jack 8-pin (2 ports): RS-232C/RS-485	
Power supply	24 VDC	24 VDC	

*1 Use a V8-specific cable as a PLC connection cable. When using the existing cable, use Hakko Electronics' conversion cable "D9-D25".
 *2 When Hakko Electronics' optional unit "TC485" is used, use an optional terminal converter "TC-D9".
 *3 When Hakko Electronics' communication I/F unit "CU-xx" is currently used, it cannot be attached to V808CDN. Use "CUN-xx" instead.

- Recommended models for replacement of V706 series (1)

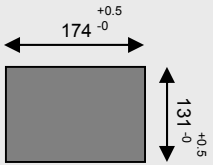
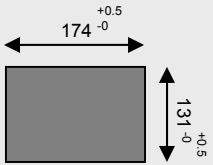
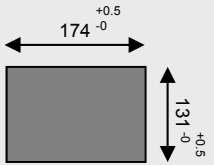
V706T series		Recommended models for replacement				
V706TD		V706TMD		V806TD/V806TDN		
MONITOUCH						
Panel cut-out dimensions (mm)						
Display device	TFT color		TFT color			
Colors	32,768 colors		65,536 colors			
Resolution	320 × 240 dots		320 × 240 dots			
Touch switch	Analog	Matrix	Analog			
Communication I/F	D-sub 25-pin: RS-232C/422/485 (with "DU-01" attached) Modular jack 8-pin (2 ports): RS-232C/422/485 *3		D-sub 9-pin: RS-232C/422/485 (with "DU-10" or "DUN-10" attached) Modular jack 8-pin (2 ports): RS-232C/422/485 *3			
Power supply	24 VDC		24 VDC			

*1 Use a V8-specific cable as a PLC connection cable. When using the existing cable and attaching "DU-10" or "DUN-10", use Hakko Electronics' conversion cable "D9-D25".
 When not attaching "DU-10" nor "DUN-10" (except for connection with a Mitsubishi A series CPU), use Hakko Electronics' conversion cable "MJ2-PLC".
 *2 In the case of V806TD/V806TDN, two points on the screen cannot be pressed simultaneously. For two-point pressing, use a switch on the screen and a function switch.
 *3 The MJ2 port can be used for connection via RS-422 (4-wire connection).
 *4 When Hakko Electronics' communication I/F unit "CU-xx" is used with the V706-specific adapter unit "CU-ADP", it cannot be attached to V806TDN. Use "CUN-xx" instead.

- Recommended models for replacement of V706 series (2)

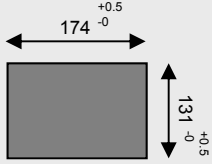
	V706C series	
	V706CD	V706CMD
MONITOUCH		
Panel cut-out dimensions (mm)		
Display device	STN color	
Colors	32,768 colors	
Resolution	320 × 240 dots	
Touch switch	Analog	Matrix
Communication I/F	D-sub 25-pin: RS-232C/422/485 (with "DU-01" attached) Modular jack 8-pin (2 ports): RS-232C/422/485 *3	
Power supply	24 VDC	

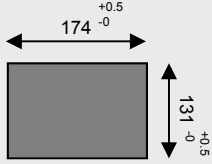
Recommended models for replacement	
V806CD/V806CDN	
	
	
STN color	
65,536 colors	
320 × 240 dots	
Analog	
D-sub 9-pin: RS-232C/422/485 (with "DU-10" or "DUN-10" attached) Modular jack 8-pin (2 ports): RS-232C/422/485 *3	
24 VDC	

*1 Use a V8-specific cable as a PLC connection cable. When using the existing cable and attaching "DU-10" or "DUN-10", use Hako Electronics' conversion cable "D9-D25".

When not attaching "DU-10" nor "DUN-10" (except for connection with a Mitsubishi A series CPU), use Hako Electronics' conversion cable "MJ2-PLC".

*2 In the case of V806CD/V806CDN, two points on the screen cannot be pressed simultaneously. For two-point pressing, use a switch on the screen and a function switch.

*3 The MJ2 port can be used for connection via RS-422 (4-wire connection).

*4 When Hako Electronics' communication I/F unit "CU-xx" is currently used with the V706-specific adapter unit "CU-ADP", it cannot be attached to V806CDN. Use "CUN-xx" instead.

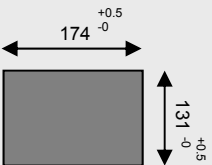
	V706M series	
	V706MD	V706MMD
MONITOUCH		
Panel cut-out dimensions (mm)		
Display device	STN monochrome	
Colors	8-level grayscale	
Resolution	320 × 240 dots	
Touch switch	Analog	Matrix
Communication I/F	D-sub 25-pin: RS-232C/422/485 (with "DU-01" attached) Modular jack 8-pin (2 ports): RS-232C/422/485 *3	
Power supply	24 VDC	

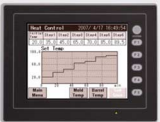
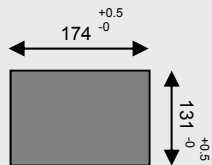
Recommended models for replacement	
V806MD/V806MDN	
	
	
STN monochrome	
16-level grayscale	
320 × 240 dots	
Analog	
D-sub 9-pin: RS-232C/422/485 (with "DU-10" or "DUN-10" attached) Modular jack 8-pin (2 ports): RS-232C/422/485 *3	
24 VDC	

*1 Use a V8-specific cable as a PLC connection cable. When using the existing cable and attaching "DU-10" or "DUN-10", use Hako Electronics' conversion cable "D9-D25".

When not attaching "DU-10" nor "DUN-10" (except for connection with a Mitsubishi A series CPU), use Hako Electronics' conversion cable "MJ2-PLC".

*2 In the case of V806MD/V806MDN, two points on the screen cannot be pressed simultaneously. For two-point pressing, use a switch on the screen and a function switch.

*3 The MJ2 port can be used for connection via RS-422 (4-wire connection).

*4 When Hako Electronics' communication I/F unit "CU-xx" is currently used with the V706-specific adapter unit "CU-ADP", it cannot be attached to V806MDN. Use "CUN-xx" instead.

- Screen program transfer

- V7 series

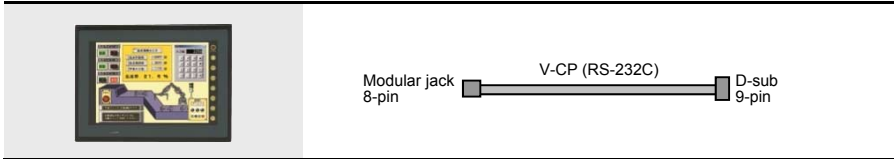

* Screen programs can also be transferred via Ethernet.

[Screen configuration software]

V-SFT-5 (Ver. 5)
 Windows 98SE / NT4.0 / Me / 2000 / XP / XP 64 Edition / Vista (32bit, 64bit) / 7 (32bit, 64bit) / 8 (32bit, 64bit) / 8.1 (32bit, 64bit) / 10 (32bit, 64bit)



- V8 series

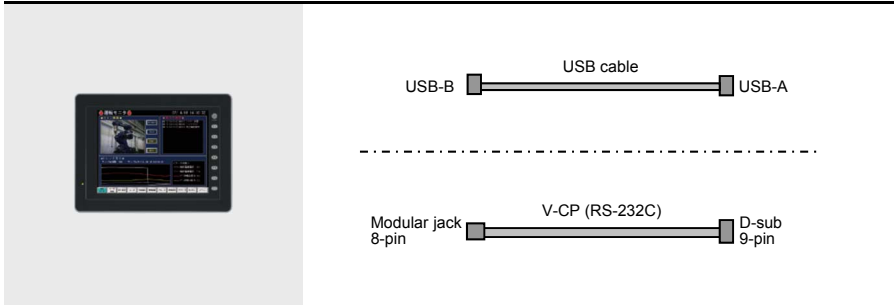

* Screen programs can also be transferred via Ethernet.

[Screen configuration software]

V-SFT-5 (Ver. 5)
 Windows 98SE / NT4.0 / Me / 2000 / XP / XP 64 Edition / Vista (32bit, 64bit) / 7 (32bit, 64bit) / 8 (32bit, 64bit) / 8.1 (32bit, 64bit) / 10 (32bit, 64bit)

V-SFT-6 (version 6)
 Windows XP / XP 64 Edition / Vista (32bit, 64bit) / 7 (32bit, 64bit) / 8 (32bit, 64bit) / 8.1 (32bit, 64bit) / 10 (32bit, 64bit)

- Screen program conversion

The V7 series can be replaced with the V8 series by converting the V7 series screen program using V-SFT-5 or V-SFT-6 (V series screen configuration software).

However, note that 100% compatibility is not ensured and some functions may be limited or may not be available after replacement.

For details, refer to the V8 Series File Conversion Manual.

* The indicated recommended model for replacement can be used with minimal restrictions. Please note that other models not described here can also be used; make a selection according to your system requirements.

Hakko Electronics Co., Ltd.

Overseas Sales Dept.

TEL: +81-76-274-2144 FAX: +81-76-274-5136

<https://monitouch.fujielectric.com/>